

# N3695: Printing

## OpenPrinting yesterday, today and ...

---

February 3, 2003

Version 0.04

Free Standards Group OpenPrinting WG

Asia/Japan Region

[shida.keisho@canon.co.jp](mailto:shida.keisho@canon.co.jp)

# Unix/Linux Printing System (1)

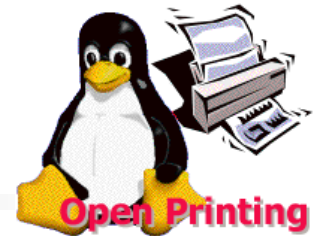

- Robust but.....
  - Legendary lpd (line printer daemon) technology
    - Focused on text based printing
  - Printer driver installed as simple data converting filter
    - No user interface
  - No standard API for printer bi-di communication
    - Status monitor have to developed by each vendor for various platform
  - Need powerful printer utility (printcap)
    - Special skill needed for printing selection/set up

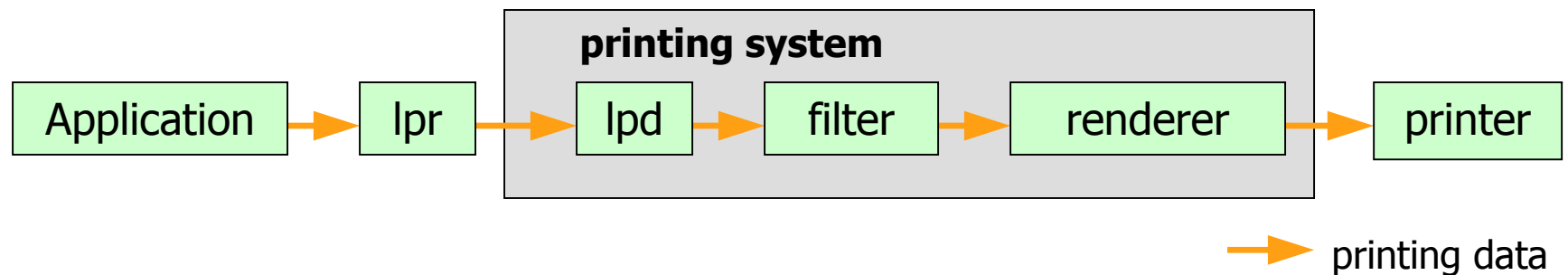

# Unix/Linux Printing System (2)

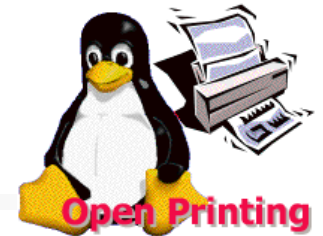

- Various printing frame work..... (Linux)
  - Foomatic
    - Free Software ([www.linuxprinting.org](http://www.linuxprinting.org))
    - Ghostscript driver + independent XML base DB
    - More than 1,000 printers
      - Brother, Canon, EPSON, HP, Lexmark.....
  - Omni Project
    - Open source printer driver (Hosted by IBM)
    - Ghostscript driver + wide use class driver + independent XML base DB
    - More than 400 printers
      - Brother, Canon, EPSON, HP, Lexmark.....



**Standard API is urgently needed!**  
**Need compatible drivers!**

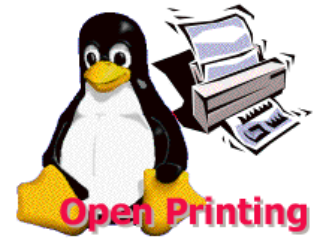

# Free Standards Group

---

## OpenPrinting WG

# OpenPrinting WG (1)

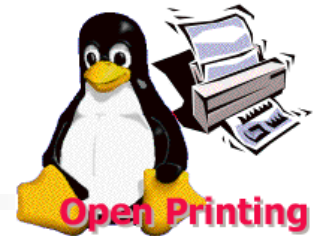

## ■ Linux Printing Forum

- Review current Linux printing related projects
- Review, identify and discuss the current issues
- Study the issues and propose the requirement for the printing  
<http://freestandards.org/printing/japan2001/>
- August 21 & 22, 2001@SGI Japan Conference hall + USA/Europe  
(participating tele conference)
  - Participants:
    - IBM, Sun Microsystems, NEC, Fujitsu, Canon, Fuji Xerox, OKI Data, Miracle Linux, Ricoh, SEIKO EPSON, OADG, JEITA, MandrakeSoft, JLA, Free Standards Group, etc.,
    - [http://members.freestandards.org/printing/japan2001/Print\\_regist.txt](http://members.freestandards.org/printing/japan2001/Print_regist.txt)

# OpenPrinting WG (2)

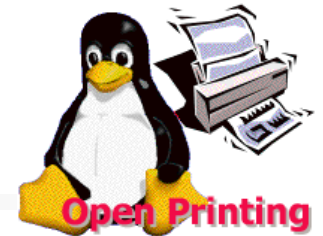

- OSDN Printing Summit 2001
  - Study the requirement for each module
  - Deliver and study the Linux Printing Forum
  - New driver presentation (HPIJS, IBM Omni)
  - October 25 & 26, 2001, San Jose, CA + tele conference (Japan)
  - Participants:
    - IBM, Sun Microsystems, HP, RedHat, MandrakeSoft, Raph Levien, Canon, Fuji Xerox, NEC, Oki Data, SEIKO EPSON, Free Standards Group etc...



Agreed to Free Standards Group (FSG) forming the work group for studying the printing related issues.

# OpenPrinting WG (3)

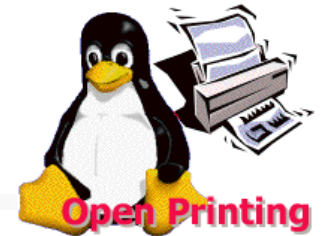

- November 2, 2001~
  - Objective
    - Develop and propose the platform/printing system independent APIs for wide use.
    - Asia/Japan regional group hosting the meetings in simultaneously
- Current task group in N. A./Europe
  - Drivers API : Spooler/Renderer  $\Leftrightarrow$  Driver
  - Spooler API : Application  $\Leftrightarrow$  Spooler
  - Capabilities API : Printer capabilities  $\Rightarrow$  Application
  - Job Ticketing API : Generating Job Ticket
- Collaborate with IEEE PWG
- Foreseeing Linux and UNIX

OpenPrinting  
"Standardizing on a Scalable Print Environment in Linux"  
a workgroup of the [Free Standards Group](#)



Latest Happenings	About OpenPrinting
<b>OpenPrinting WG announced!</b>	<b>Workgroup Definition Docs</b>
<b>Current Task Groups:</b> <ul style="list-style-type: none"><li>• Job Capabilities<ul style="list-style-type: none"><li>◦ <a href="#">Draft v1</a></li><li>◦ <a href="#">Jobsets diagram</a></li></ul></li><li>• Print Driver</li></ul>	<ul style="list-style-type: none"><li>• <a href="#">OpenPrinting WG Definition</a></li><li>• <a href="#">OpenPrinting Technical Overview</a></li><li>• <a href="#">OpenPrinting Organizational Layout</a></li><li>• <a href="#">OpenPrinting Decision Process</a></li><li>• <a href="#">OpenPrinting Communication Process</a></li></ul>

# OpenPrinting WG (4)

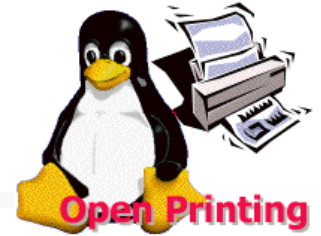

- Activity in Japan
  - Vector Device Driver API
    - Study the current raster based driver frame works
      - Will it meet with high speed/performance printers such as LBP...
    - Need Ghostscript independent API for non-PS, non-PCL based printers.
    - Leader: Mihara, Osamu (Fuji Xerox Printing Systems)
  - Bi-di Plug-in API
    - API for printer status infors such as remaining ink level, option devices (paper cassette or HD, etc.,) to upper level filter.
    - Leader: Toratani, Yasumasa (Canon Inc.,)



# OpenPrinting WG (5)

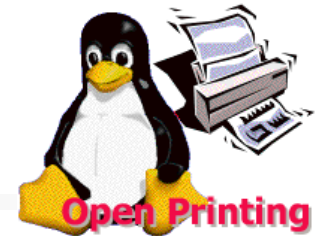

- Vector Device Driver API and Bi-di Plug-in API in the CUPS**

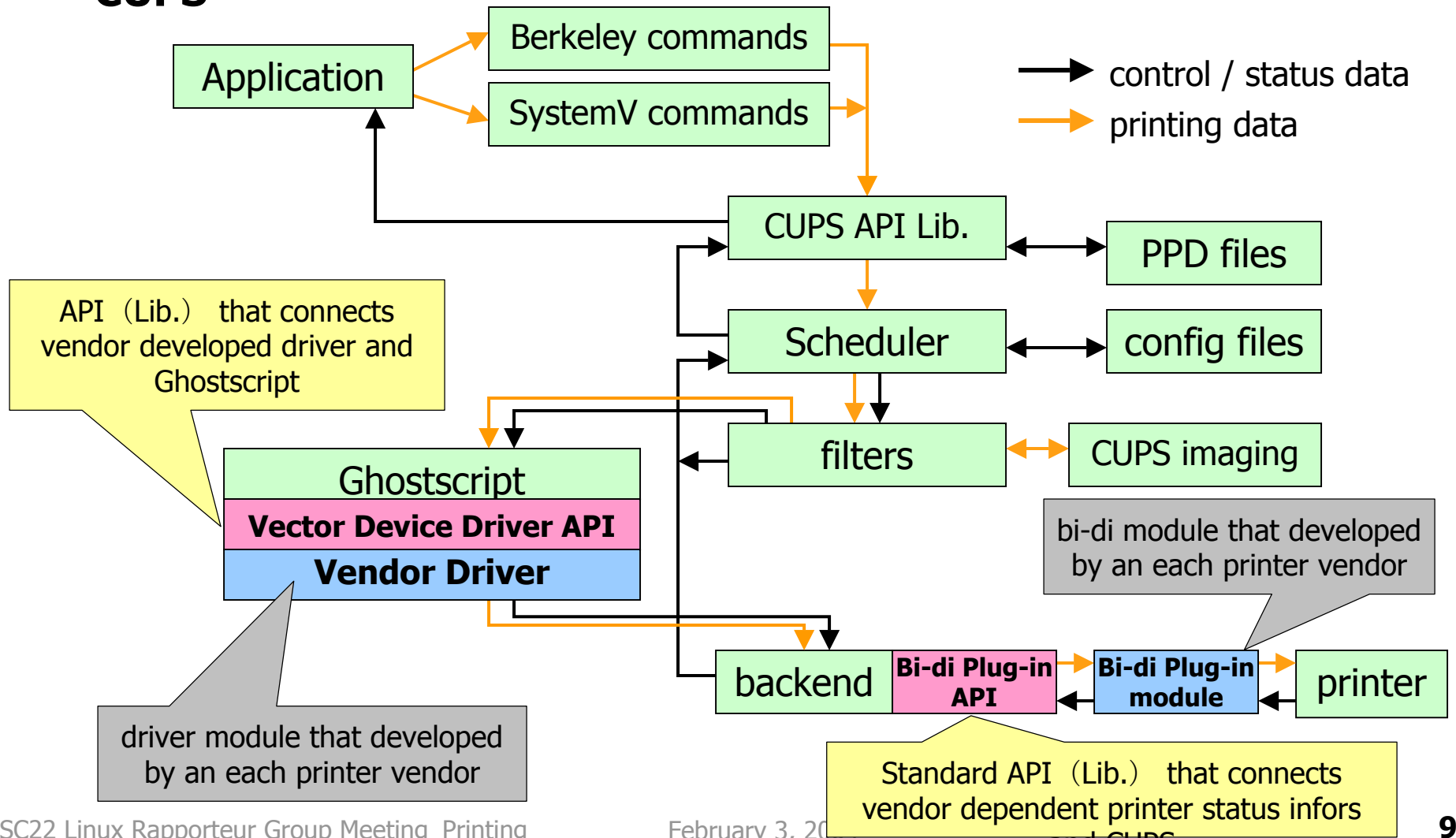

# OpenPrinting WG (6)

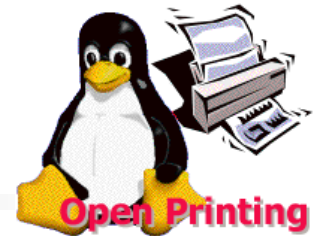

- PWG/FSG Joint Meeting in Portland (2003.06.17)
  - Reported current activity in Japan
  
- Vector Device Driver API draft (2004.01.15)
  - <http://omihara.hp.infoseek.co.jp/unixprint/vector/VectorPrinterDriverAPI0.2.pdf> (preliminary) --- English written document: TBD
  
- Bi-di Plug-in API draft (2003.12.20)
  - [http://www2s.biglobe.ne.jp/~papadon/OpenPrinting/BidiPluginAPI/BiDiAPI\\_draft\\_20031220.pdf](http://www2s.biglobe.ne.jp/~papadon/OpenPrinting/BidiPluginAPI/BiDiAPI_draft_20031220.pdf) (preliminary) --- English written document: TBD

謝々！

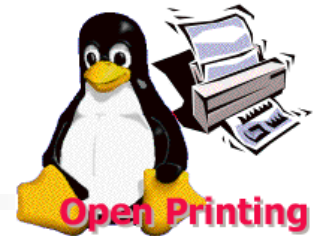

Thank you! Merci beaucoup!

Please let us have a time to complete  
the current study.

Then lets discuss the issues  
how we should manage to further study.

# Appendix

---

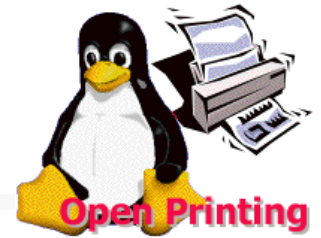

Appendix  
Appendix Appendix  
Appendix Appendix Appendix

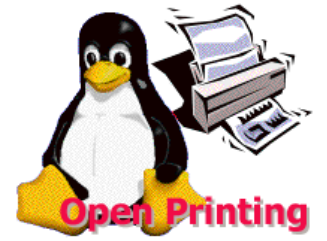

# Open Printing Project

---

# Open Printing Project (1)

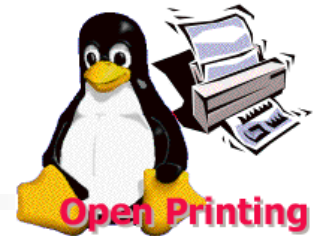

- Background

- Information technology Promotion Agency (IPA) , a subsidiary division of METI, have fund for open source related development project from the public in spring 2003.

<http://www.ipa.go.jp/NBP/open/2003/koubo/index.html>



## Forms the Open Printing Project

- Objective

- Integrate the APIs that developed by the Free Standards Group OpenPrinting WG activities.
- Promote the API along with the above integration as reference from Asia/Japan.

# Open Printing Project (2)

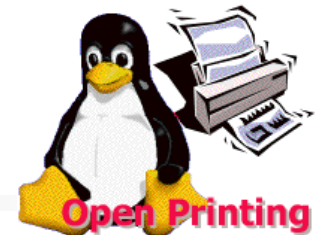

- Open Printing WG and Open Printing Project

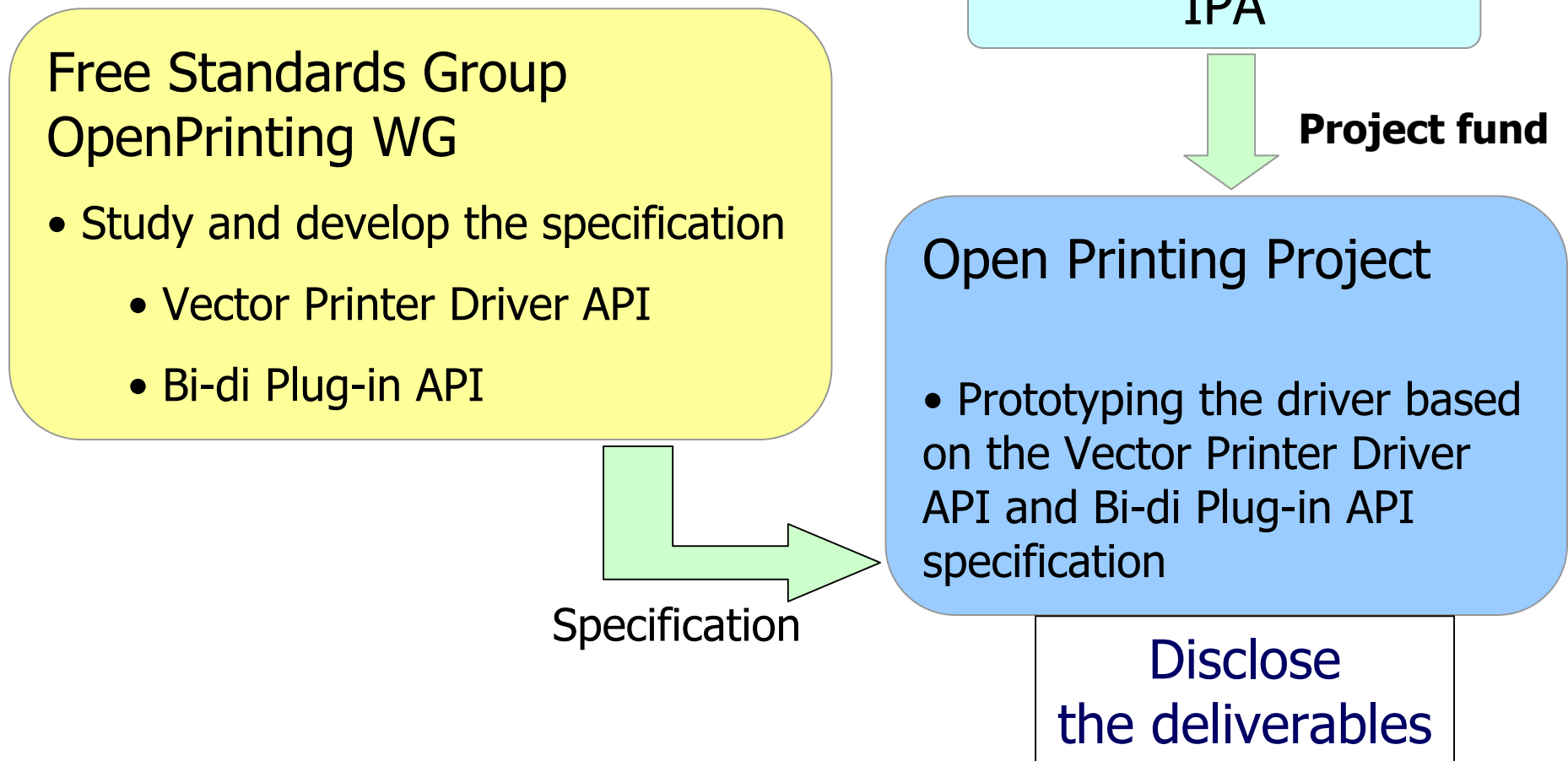

# Appendix

---



Appendix  
Appendix Appendix  
Appendix Appendix Appendix



# Unix/Linux Printing System (2)

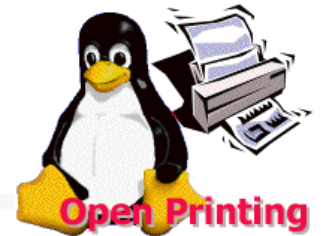

- Integration is vary depend on the platform
  - BSD                      IRIX, Digital UNIX, FreeBSD, Linux
  - SystemV                HP-UX, Solaris (older version)
  - SystemV V.4          SCO UNIX, Solaris
  - AIX                      IBM
    - Job control commands are vary....
      - job start/delete, stop/resume, interrupt, etc.,
    - Various printing functions are vary....
      - selecting printing order, printing function, etc.,
    - These systems offers different functionality in own each version
- Printer vendor needs various support for each of above!
- Matching display and print?
  - Printing: Unix/Linux is PostScript base
  - Display: Unix/Linux is Window system base
  - Font handling and Color control are different.

# OpenPrinting WG (3)

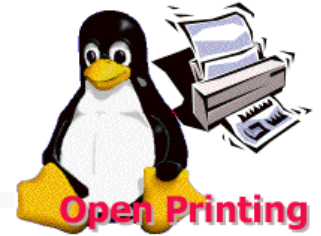

- Free Standards Group
  - Study and promote the open standards for Linux
    - LSB : System configuration for distribution
    - OpenI18N: Internationalization
    - LANANA: Linux name space
    - **OpenPrinting :** **Study printing API**
  - Members
    - Corporate members:  
HP, IBM, Intel  
Connectiva, MandrakeSoft, MiracleLinux MontaVista, RedHat,  
Sun Microsystems, SuSE, Turbolinux, VA, AMD, Dell
    - Non-profit members:
      - OADG, JLA, etc.
  - [www.freestandars.org](http://www.freestandars.org)

